



QR406/QR406F/QR406D/QD406S

SUPERFAST RECOVERY RECTIFIERS

VOLTAGE 600 Volt **CURRENT** 4 Ampere

FEATURES

- Planar structure with EPI wafer
- Ultrafast recovery time, low V_f and soft recovery
- For PFC DCM operation
- Low leakage current
- Plastic package has Underwriters Laboratory Flammability Classification 94V-O Flame Retardant Epoxy Molding Compound
- Exceeds environmental standards of MIL-S-19500/228
- Lead free in compliance with EU RoHS 2011/65/EU directive
- Green molding compound as per IEC61249 Std. . (Halogen Free) (TO-252)

MECHANICAL DATA

- Case: TO-220AC, ITO-220AC, TO-263, TO-252 package
- Terminals: Lead solderable per MIL-STD-750, Method 2026
- TO-220AC Weight: 0.065 ounces, 1.859 grams
- ITO-220AC Weight: 0.055 ounces, 1.5615 grams
- TO-263 Weight: 0.051 ounces, 1.46 grams
- TO-252 Weight: 0.0104 ounces, 0.297 grams

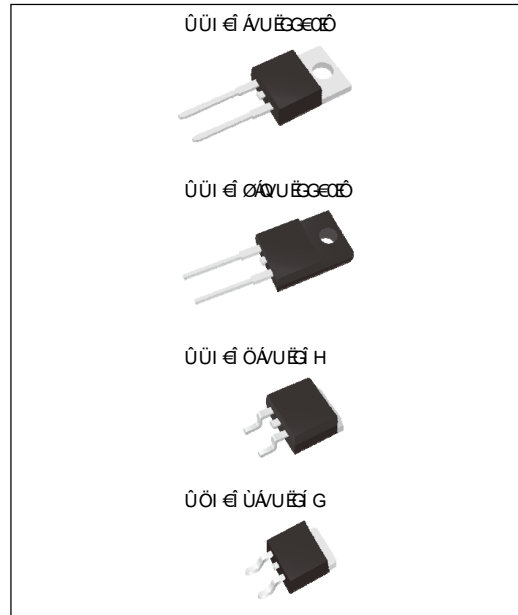

MAXIMUM RATINGS(T_A=25°C unless otherwise noted)

PARAMETER	SYMBOL	VALUE	UNIT
Maximum recurrent peak reverse voltage	V _{RRM}	600	V
Maximum rms voltage	V _{RMS}	420	V
Maximum dc blocking voltage	V _R	600	V
Maximum average forward rectified current	I _{F(AV)}	4	A
Peak forward surge current 8.3ms single half sine-wave superimposed on rated load	I _{FSM}	35	A
Typical thermal resistance	TO-220AC(Note 1)	2	°C/W
	ITO-220AC(Note 1)	5.5	
	TO-263 (Note 1)	2	
	TO-252 (Note 2)	5.5	
Operating junction temperature range	T _J	-55 to + 150	°C
Storage temperature range	T _{STG}	-55 to + 150	°C

NOTE :

1. Device mounted on a infinite heatsink , then measured the center of the marking side.
2. Device mounted on a 10cm*10cm*0.5mm copper pad area , then measured the center of the marking side.



QR406/QR406F/QR406D/QD406S

ELECTRICAL CHARACTERISTICS(T_A=25°C unless otherwise noted)

PARAMETER	SYMBOL	TEST CONDITIONS	MIN.	TYP.	MAX.	UNIT
Breakdown voltage	V _{BR}	I _R =100μA T _J =25°C	600	-	-	V
Instantaneous forward voltage	V _F	I _F =1A T _J =25°C	-	1.02	-	V
		I _F =4A T _J =25°C	-	1.23	1.45	V
Instantaneous forward voltage	V _F	I _F =1A T _J =125°C	-	0.84	-	V
		I _F =4A T _J =125°C	-	1.1	1.3	V
Reverse leakage current	I _R	V _R =600V T _J =25°C	-	-	3	μA
Reverse recovery time	T _{RR}	I _F =0.5A I _R =1A I _{RR} =0.25A T _J =25°C	-	-	45	ns
		I _F =1A V _R =30V di/dt=100A/μs T _J =25°C	-	-	35	ns
		I _F =4A V _R =400V di/dt=200A/μs T _J =25°C	-	60	-	ns
Peak recovery current	I _{RRM}	I _F =4A V _R =400V di/dt=200A/μs T _J =25°C	-	4	-	A
Reverse recovery charge	Q _{RR}	I _F =4A V _R =400V di/dt=200A/μs T _J =25°C	-	135	-	nC



QR406/QR406F/QR406D/QD406S

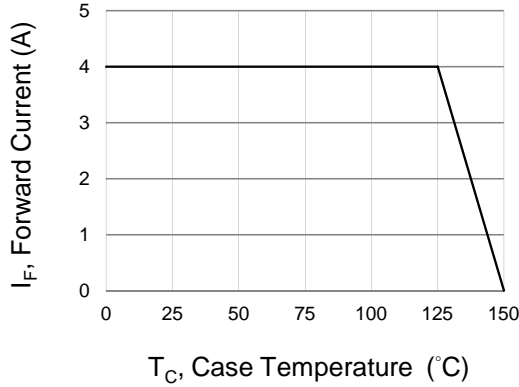

Fig.1 Forward Current Derating Curve

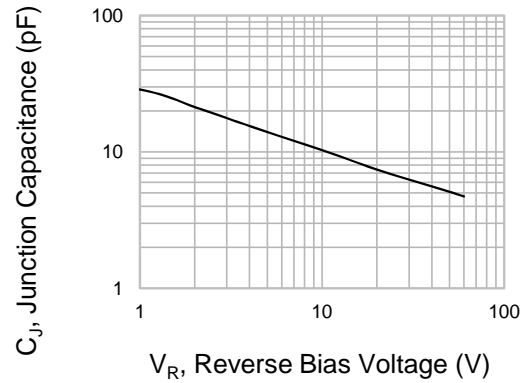

Fig.2 Typical Junction Capacitance

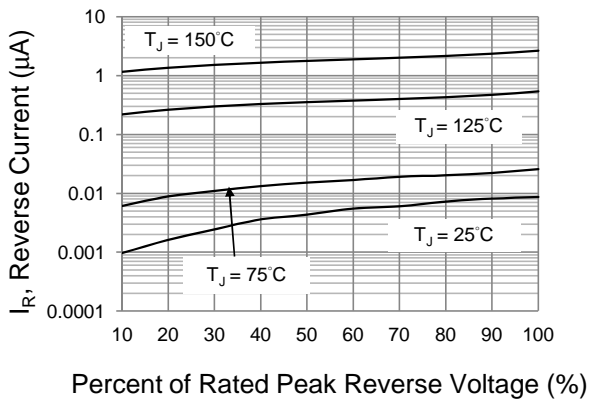

Fig.3 Typical Reverse Characteristics

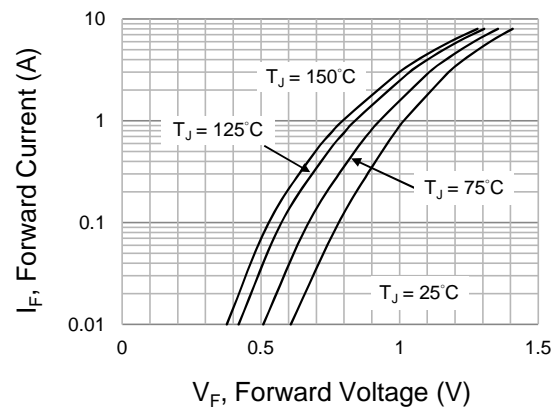

Fig.4 Typical Forward Characteristics

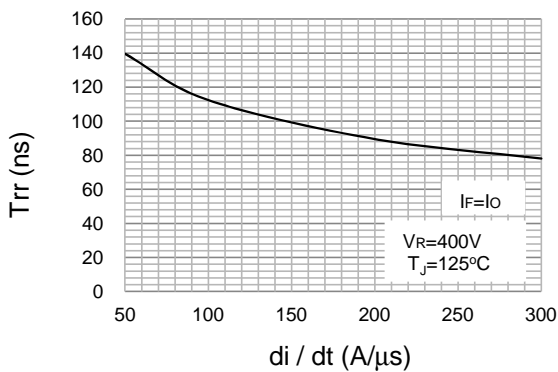

Fig.5 Typical Reverse recovery time versus di/dt

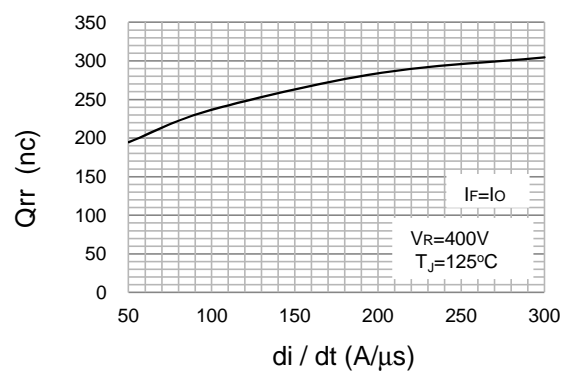

Fig.6 Typical Reverse recovery charges versus di/dt



QR406/QR406F/QR406D/QD406S

TO-220AC

Unit : inch(mm)

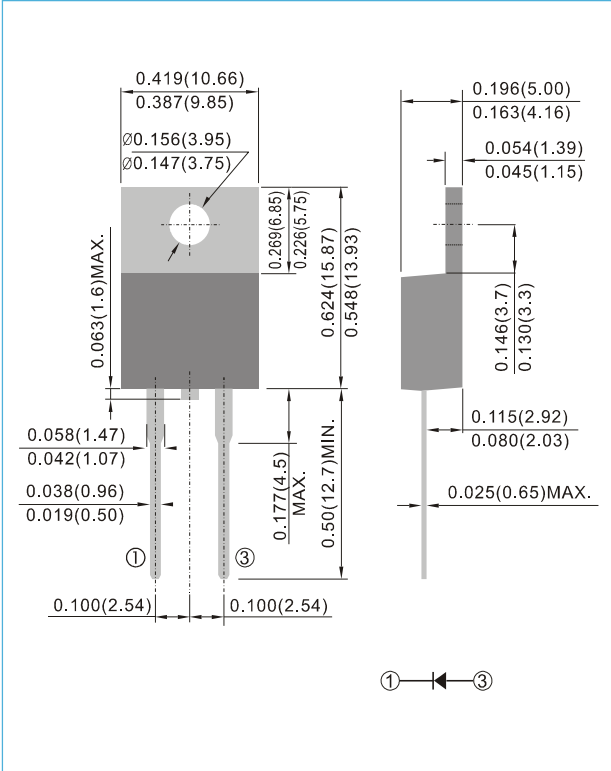

ITO-220AC

Unit : inch(mm)

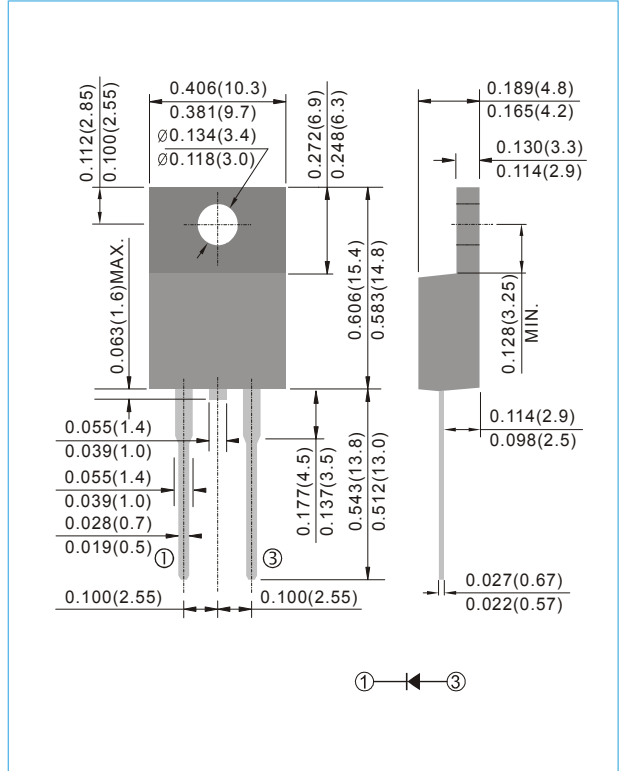

TO-263 / D²PAK

Unit : inch(mm)

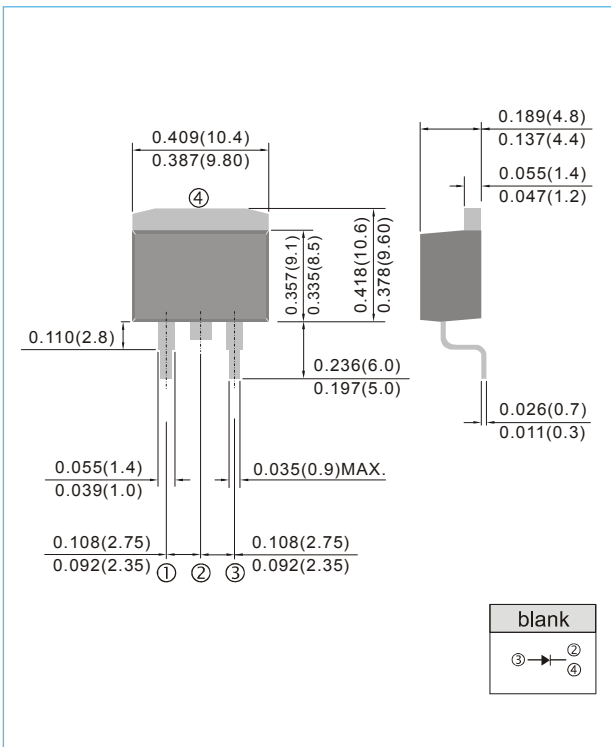

TO-252

Unit : inch(mm)

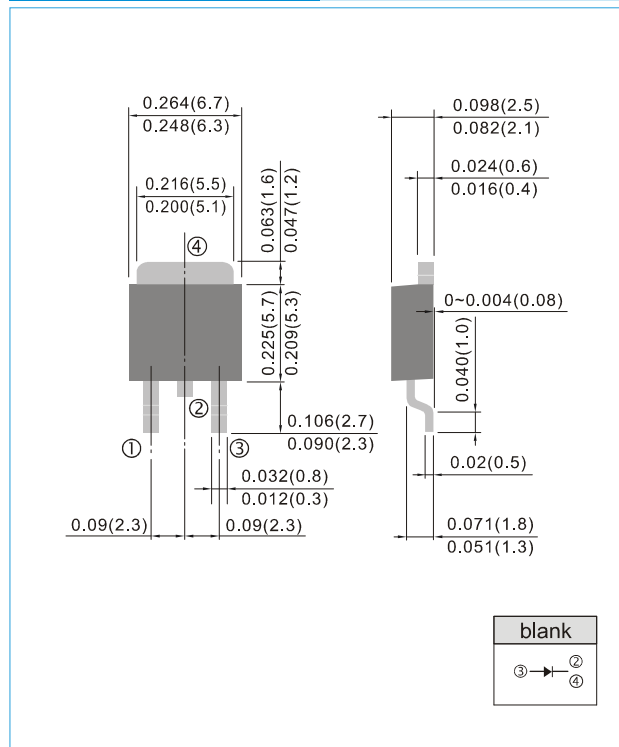



QR406/QR406F/QR406D/QD406S

MOUNTING PAD LAYOUT

TO-252

Unit : inch(mm)

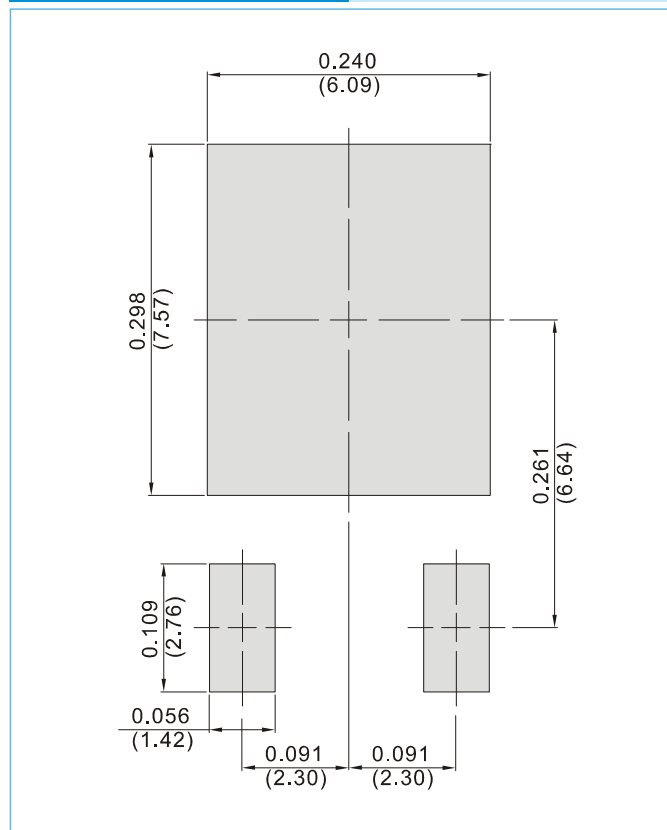

ORDER INFORMATION

- Packing information
T/R - 3K per 13" plastic Reel



QR406/QR406F/QR406D/QD406S

MOUNTING PAD LAYOUT

TO-263 / D²PAK

Unit : inch(mm)

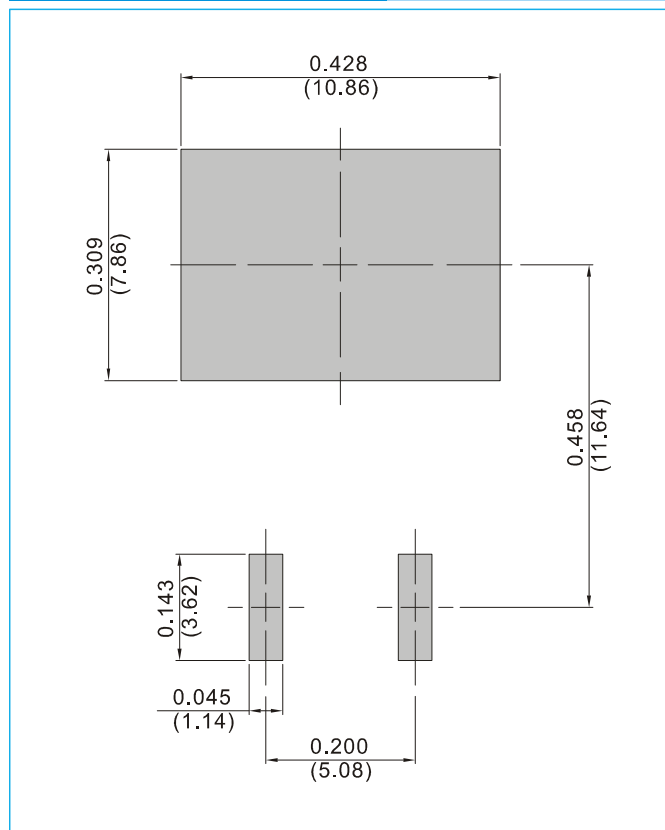

ORDER INFORMATION

- Packing information
T/R - 0.8K per 13" plastic Reel



QR406/QR406F/QR406D/QD406S

Part No_packing code_Version

QR406_T0_00001
 QR406_T0_10001
 QR406F_T0_00001
 QR406F_T0_10001
 QR406D_R2_00001
 QR406D_R2_10001
 QD406S_T0_00001

For example :

RB500V-40_R2_00001

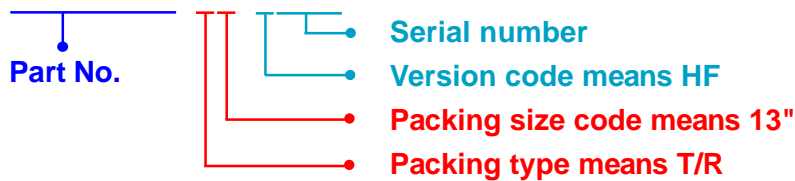

Packing Code XX				Version Code XXXXX		
Packing type	1 st Code	Packing size code	2 nd Code	HF or RoHS	1 st Code	2 nd ~5 th Code
Tape and Ammunition Box (T/B)	A	N/A	0	HF	0	serial number
Tape and Reel (T/R)	R	7"	1	RoHS	1	serial number
Bulk Packing (B/P)	B	13"	2			
Tube Packing (T/P)	T	26mm	X			
Tape and Reel (Right Oriented) (TRR)	S	52mm	Y			
Tape and Reel (Left Oriented) (TRL)	L	PANASERT T/B CATHODE UP (PBCU)	U			
FORMING	F	PANASERT T/B CATHODE DOWN (PBCD)	D			



QR406/QR406F/QR406D/QD406S

Disclaimer

- Reproducing and modifying information of the document is prohibited without permission from Panjit International Inc..
- Panjit International Inc. reserves the rights to make changes of the content herein the document anytime without notification. Please refer to our website for the latest document.
- Panjit International Inc. disclaims any and all liability arising out of the application or use of any product including damages incidentally and consequentially occurred.
- Panjit International Inc. does not assume any and all implied warranties, including warranties of fitness for particular purpose, non-infringement and merchantability.
- Applications shown on the herein document are examples of standard use and operation. Customers are responsible in comprehending the suitable use in particular applications. Panjit International Inc. makes no representation or warranty that such applications will be suitable for the specified use without further testing or modification.
- The products shown herein are not designed and authorized for equipments requiring high level of reliability or relating to human life and for any applications concerning life-saving or life-sustaining, such as medical instruments, transportation equipment, aerospace machinery et cetera. Customers using or selling these products for use in such applications do so at their own risk and agree to fully indemnify Panjit International Inc. for any damages resulting from such improper use or sale.
- Since Panjit uses lot number as the tracking base, please provide the lot number for tracking when complaining.